

Quarterly Technical Summary

Division 6

Radar Techniques Program

15 August 1970

Issued 22 September 1970

Prepared for the Department of the Air Force
and the Advanced Research Projects Agency
under Electronic Systems Division Contract AF 19(628)-5167 by

Lincoln Laboratory

MASSACHUSETTS INSTITUTE OF TECHNOLOGY

Lexington, Massachusetts



This document is
not for foreign nation

Approved for Public Release.
Distribution Unlimited.

not for foreign governments

20100812 166

The work reported in this document was performed at Lincoln Laboratory, a center for research operated by Massachusetts Institute of Technology. This work was sponsored in part by the Department of the Air Force under Contract AF 19(628)-5167 and in part by the Advanced Research Projects Agency of the Department of Defense under Contract AF 19(628)-5167 (ARPA Order 1559).

This report may be reproduced to satisfy needs of U.S. Government agencies.

Non-Lincoln Recipients

PLEASE DO NOT RETURN

Permission is given to destroy this document
when it is no longer needed.

INTRODUCTION

This quarterly technical summary of the Radar Techniques Program, formerly called Tactical Radar Program, covers the period 1 May through 30 July 1970.

The goal of the program is the application of modern techniques to the design of advanced Doppler radars for both ground and aircraft application. Work on ground-based radar, including propagation studies, is concentrated in Group 68. The digital signal processing work is performed principally in Group 64. Both groups collaborate in airborne radar work.

Work at the Florida site on both propagation and spectral measurements is concluding. Most of the UHF and L-band data have been gathered with some spectral clutter tests still to be made during the next month. Reduction of data from the tests will continue throughout the next quarter.

The demonstration radar system which incorporates the Fast Digital Processor (FDP) is proceeding on schedule. The antenna and tower structure are being fabricated with erection planned for the Lexington Field Station. The FDP, with the exception of three arithmetic elements (AEs), has been assembled and system tests have started. The AEs are on schedule.

Work continues on airborne systems in the areas of multiple aperture antennas and advanced signal processing.

15 August 1970

Irwin L. Lebow
Program Manager

Accepted for the Air Force
Joseph R. Waterman, Lt. Col., USAF
Chief, Lincoln Laboratory Project Office

CONTENTS

| | |
|--|-----|
| Introduction | iii |
| Organization | vi |
| | |
| GROUP 64 – DIGITAL SIGNAL PROCESSING | 1 |
| I. General Introduction | 1 |
| II. Introduction to FDP | 1 |
| A. Arithmetic Elements (AEs) | 1 |
| B. Control and Console | 1 |
| C. Memories | 2 |
| D. Cabinets | 2 |
| III. Demonstration Radar | 2 |
| IV. Airborne Radar Digital Signal Processor | 2 |
| | |
| GROUP 68 – RADAR | 5 |
| I. Florida Measurements Program | 5 |
| A. Introduction | 5 |
| B. L-Band Measurement System | 5 |
| C. Computer Programs | 7 |
| D. Dielectric Slab Propagation Model | 8 |
| E. Experimental Results | 9 |
| II. Demonstration Radar | 13 |
| A. Introduction | 13 |
| B. Antenna | 14 |
| C. Antenna Switching | 15 |
| D. Preprocessor | 16 |
| III. Airborne Radar | 18 |
| A. Introduction | 18 |
| B. Multiple-Antenna Airborne Radar Study | 19 |
| C. Ground Clutter and Target Returns at Small Depression Angles | 20 |

ORGANIZATION

DIVISION OFFICE

JOHN M. WOZENCRAFT, *Head*
IRWIN L. LEBOW, *Associate Head*
STANTON GOULD, *Assistant*

GROUP 64

B. GOLD, *Leader*

| | |
|-------------------|-----------------|
| T. BIALLY | P. G. MCHUGH |
| P. E. BLANKENSHIP | M. P. MULLO |
| J. D. DRINAN | F. NAGY, JR. |
| E. M. HOFSTETTER | J. TIERNEY |
| A. H. HUNTOON | C. J. WEINSTEIN |

GROUP 68

C. E. MUEHE, *Leader*

L. W. BOWLES, *Associate Leader, Acting Leader*

| | |
|--------------------|-----------------|
| R. N. ASSALY | K. J. KEEPING |
| L. CARTLEDGE | M. LABITT |
| W. H. DRURY | P. B. MCCORISON |
| M. P. FRASER | J. H. TEELE |
| T. M. HENDRICKS | R. D. YATES |
| W. A. JANVRIN, JR. | |

DIGITAL SIGNAL PROCESSING

GROUP 64

I. GENERAL INTRODUCTION

The present work of Group 64 is threefold. First is the design and construction of a unique general-purpose computing facility that centers around the Fast Digital Processor (FDP) which has been discussed in previous quarterly technical summaries. Next is the design and construction of a demonstration radar facility which will incorporate an electronically scanned ground-based antenna system, a versatile range-gate selection system and general-purpose radar signal processing capabilities using the FDP. This work is being carried out in cooperation with Group 68. The third aspect of our work, also with Group 68, is a study effort aimed at sorting out the advanced airborne radar problems of greatest utility. Specific interests in this last area include the use of synthetic operative techniques for high angular resolution of moving targets, algorithms for range-gate selection and the architecture of multimode, general-purpose airborne radar digital signal processors.

II. INTRODUCTION TO FDP

The FDP-Univac 1219 facility, when finished, will increase the overall computing power of the present Univac 1219 facility by one to two orders of magnitude. This speed increase comes from the use of a 150-nsec "cache" memory, program pipelining at several levels and the incorporation of four interconnected high speed arithmetic units into the structure. It is estimated that signal processing programs, such as one finds in speech technology, radar technology or communications technology can run from 100 to 200 times faster on the future facility as compared to the present facility. Other programs, such as matrix inversion and elementary computations (sine, cosine, logarithm, etc.) run about fifty times faster. Presently, we are investigating the slowdowns that could be caused by a large program which overloads the cache memory.

The FDP consists of two data memories M^a and M^b , each 18 bits by 1024 registers, a program memory M^c of 36 bits by 256 registers, 4 arithmetic elements (AEs), two control frames CONF1 and CONF2, and a console-interface frame (CIF).

Progress on the FDP has been discussed in previous quarterly technical summaries. The major accomplishments during the past quarter are summarized below.

A. Arithmetic Elements (AEs)

AE 2 was assembled and tested.

The AE 3 panels were tested and assembled in a frame. The frame is now connected to the AE tester, and it is undergoing final checkout.

The prototype AE was taken apart, and its panels are being assembled on a frame.

Eight of the ten AE 4 panels were tested.

B. Control and Console

Testing of CONF1, CONF2, and the control tester was completed.

A data memory, control memory, and the prototype AE were connected to the above combination and all ran successfully.

The construction of the console was completed, and it was tested with the C1F.

C. Memories

The second data memory, the control memory, and the bootstrap memory were all run successfully with the memory tester.

D. Cabinets

The fourth cabinet was completed, and all cabinets are now in place.

The AC and DC power distribution system wiring is near completion and will be tested soon.

The four memories, the console, AE 2, CONF1, CONF2, and C1F are in the cabinets, and final interconnection of these units is proceeding.

III. DEMONSTRATION RADAR

The system design of the ground-based radar is being undertaken jointly with Group 68. Recent discussions have centered around the design of a preprocessor that performs complementary waveform summing, selects range gates, and pre-sums data before presenting it to the FDP for further processing. It appears that the preprocessor can be constructed of metal-oxide-semiconductor (MOS) shift register memories and a relatively small amount of control electronics. Experiments leading to the design of the MOS memory subsystems are currently in progress.

The preprocessor will be situated at the Lexington Field Station and will deliver data via a coaxial cable link to a large core memory in B building. Cables have been ordered for this purpose, and will be installed in an existing underground duct that runs from the field station to the Laboratory. Communications will be via a serial FSK (frequency shift keyed) system operating at about 1.31 megabits per second.

The large core memory, consisting of 163,840 20-bit words has been ordered and delivery is expected in early December. The memory will be controlled by a special purpose addressing device, which is currently being designed. Both input buffering and postdetection integration functions will be performed by the large core memory system.

The software problem for the ground-based radar can be divided into three subproblems. One is the software support of the FDP - Univac 1219 facility. In order to make this facility efficient, the drum-handling programs must be incorporated into the facility. This work is presently under way. Following this the FDP radar signal processing programs must be written and tested. The third subproblem, being carried out by Group 68, is the software system required for control of the radar antenna, preprocessor and display.

IV. AIRBORNE RADAR DIGITAL SIGNAL PROCESSOR

A study of the requirements of various airborne radar systems and the state of the art in digital hardware has indicated the possibility of a flyable digital signal processor that could fit a variety of radar situations.

We would demand of such a processor the highest possible speed, generality of signal processing capability, and small size and weight.

The generality of signal processing would allow the processor to fit into many radar applications, including airborne surveillance, interception, ground mapping, and even severe storm tracking. Also, for any particular radar task, one might wish to make changes in the signal processing algorithms after the radar has been built, and such changes could easily be made with a general-purpose processor. One often wishes an airborne radar to operate in several modes (e.g., AMTI, tracking, and synthetic aperture ground mapping). A general-purpose digital processor seems quite suitable for multimode operations.

A starting point for designing such a processor would be the architecture of the FDP. Certain additional features such as a large memory to store the data from the many range gates, would be needed. B. Gold and C. E. Muehe* have presented in some detail a possible architecture for a radar digital signal processor of the type we have been discussing.

With recent hardware advances in multipliers and integrated circuit memories, it seems possible to build a flyable processor which would operate about six times faster than the FDP, with generality comparable to that of the FDP.

* B. Gold and C. E. Muehe, "Digital Signal Processing for Range-Gated Pulse Doppler Radars," presented at XIXth Avionics Panel Technical Symposium on Advanced Radar Systems, Istanbul, Turkey, May 1970.

RADAR GROUP 68

I. FLORIDA MEASUREMENTS PROGRAM

A. Introduction

The purpose of the Florida measurements program is to obtain experimental data for the formulation of propagation models that will accurately predict radar performance under a variety of foliage conditions.

A series of two-way propagation experiments to determine the range dependence of signal power and clutter power was completed early in the program. More recently, one-way propagation experiments with a remote field probe receiver were undertaken in order to obtain more detailed information on the mechanism of radar propagation in foliated areas.

The design of radar signal processors for the detection of slowly moving personnel in foliage requires a knowledge of the spectral characteristics of windblown clutter, as well as those of the moving target. Hence, another aspect of the measurements program is the determination of radar clutter spectra as a function of the nature and velocity of the wind. In addition, target spectral characteristics will be evaluated.

The initial experiments under this program were all performed at UHF. More recently the scope of the program was enlarged to include additional experiments at L-band frequencies.

During this past quarter a new foliated area was selected for propagation experiments and clutter spectral measurements. The L-band measurements radar and an L-band probe receiver are now in operation. A large number of field probe measurements at both UHF and L-band was completed.

The computer program for on-site spectral analysis with the Raytheon 706 computer has been modified to give increased dynamic range and a new program for the digital recording of radar data is operating. Variable gain data amplifiers and filters were installed to permit full dynamic range recording of spectral data. The magnetic tapes are being processed with the IBM 360 computer at Lincoln Laboratory to obtain high quality estimates for the spectra of wind-blown foliage and targets.

B. L-Band Measurement System

1. L-Band Transmitter and Receiver

The airborne transmitter, utilized in the helicopter-borne radar, has been successfully modified as described in the last quarterly technical summary. It is presently operating at the Everglades field site. Some pertinent system parameters are given in Table I.

2. L-Band Antenna

This antenna was completed on schedule and sent to the test site during the first week of June. It provides a total 3-dB beamwidth of 5.5° in azimuth and approximately 42° in the vertical plane. The gain is estimated to be about 22 dB relative to isotropic. The antenna is required to handle a peak-power level of 5 kW and average power not to exceed 5 watts. It is a linear array

TABLE I
L-BAND PARAMETERS

| | |
|-------------------------------------|------------|
| Operating frequency | 1305 MHz |
| Pulse repetition frequency, maximum | 31,250 pps |
| RF pulse width, 3 dB | 32 nsec |
| RF rise time, 10 to 90% | 6 nsec |
| RF fall time, 90 to 10% | 2 nsec |
| Calculated duty, maximum | 0.001 |
| Transmitter RF output, peak | 5.3 kW |
| First harmonic power level | -30 dB |
| Second harmonic power level | -40 dB |
| RF bandwidth, 3 dB | 32 MHz |
| Transmitter ON/OFF ratio | >180 dB |
| L-band/UHF conversion loss | <10 dB |

of collinear horizontally polarized half-wave dipoles mounted in a 90° corner reflector. The reflector is 10 feet long horizontally and 9 inches high.

The feed system for the antenna makes use of two 8 × 8 Butler matrices. The beam input terminals of each of these matrices are terminated in 50-ohm loads except for beams 1R and 1L in each case. These four terminals are fed at equal amplitude and in phase from a one- to four-way power splitter. Equal line lengths connect the outputs to the individual antenna elements. The matrix outputs are interlaced so that the aperture amplitude distribution is approximately cosinusoidal.

The complete antenna and feed network were tested at the Bedford antenna range with the results already given. The phase errors arising from the network and the elements themselves resulted in a peak sidelobe level of about 14 dB. The antenna performance meets the system requirements and no particular efforts were made to reduce the sidelobe level principally because of the time available.

3. L-Band Field Probe

We now have the capability of making field strength measurements at both 435 and 1305 MHz. The L-band probe receiver has a tangential signal sensitivity on the order of -75 dBm for a 35-nsec signal pulsewidth at 1305 MHz and is linear for inputs as large as -13 dBm. It is presently in use at our Florida test site.

An effort was made to mount a UHF dipole and an L-band dipole on the same ground plane. The ground plane (which must be moved vertically up and down a mast) is about 3 feet square. Experimentally it was found that the L-band dipole could not be adequately shielded from the UHF dipole which readily absorbs L-band power. This showed up on the radiation patterns of the L-band dipole as large gain variations and perturbations of its pattern. Finally, it was decided

to use only one dipole at a time. Each of these dipoles individually has a VSWR ≤ 1.3 and a gain of 8.8 dB above isotropic at its respective band center.

C. Computer Programs

1. On-Site Spectral Analysis Program

The real-time spectral analysis program written last quarter for the 706 computer continues in use for radar evaluation. Two minor modifications have been made to increase the utility and convenience of operation of the program.

First, a routine has been added which re-inserts the DC component of the input for display in its proper position on the face of the read-out oscilloscope. This addition makes absolute calibrations easier and permits direct measurement of DC/AC ratios of input signals.

Second, a minor bug has been found and fixed with the result that direct transfer to the 706 supervisor routines can be made from the teletype keyboard. The importance of this is that the entire Florida software package can now be operated from the remote ASR-33 console located in the radar van.

2. Data Recording Program

In the past quarter, a program has been written for recording range-gated radar data on IBM-compatible magnetic tape. Inputs from the in-phase and quadrature channels of ten range gates are digitized and written on tape in records of 8000 bytes each. Digitization is performed with ten-bit resolution and the sampling interval for each range gate is 10-msec minimum. Time jitter in sampling has been held under $75 \mu\text{sec}$. In addition to range-gate data, auxiliary data are recorded on the output tape. An operator-entered comment is written along with a series of 256 coded bits which indicate date, time, radar configuration, antenna azimuth, experiment type and number, etc. Also recorded is another 256-bit sequence giving computer program parameters, error conditions, and computer control settings. The program samples twelve additional analog input channels at longer intervals and records the digitized result. The auxiliary data and extra channels are tested and recorded every 140 msec.

3. Spectral Estimation Program

The philosophy of the spectral estimation program is to gather data at the site and process that data almost exclusively at the Laboratory. This is to allow the use of several different processing algorithms for the extraction of useful data. The site now generates tapes that contain primarily time series data that represent the clutter and/or target waveforms along with pertinent equipment, weather, and bookkeeping data. The tapes generated in Florida are sent to Lincoln Laboratory where they are processed on the IBM 360 computer system.

The 360 computer spectral estimation program has been written and performs well. It takes the time series data, averages N numbers (real and imaginary) to form a complex point in a new time series. Then a discrete Fourier transform (DFT) is taken of these time-weighted complex points. The DFTs are then averaged to provide the spectrum estimation. The more DFTs that are averaged, the more accurate the spectral estimation becomes. The accuracy of the estimation can and has been calculated and will be presented in a later report.

The effect of averaging N terms is analogous to low-pass filtering. However, the purpose of this averaging is to provide adequate frequency resolution around zero frequency where most of the clutter energy resides without using the very large amount of computer time which would be needed if a DFT of many points were used to obtain the required resolution.

Along with the spectra, the program also computes the average, variance, and AC-to-DC ratios of the time series and plots the results using the sc4060 plotter. To check the spectral estimation program, another program was written to generate an artificial time series that simulated ground clutter. In principle, it was done by passing white digital noise (generated by standard routines) through a digital filter. This digital filter is essentially a set of difference equations, and has a response corresponding to that of a Butterworth low-pass filter which is flat out to 1 Hz, then rolls off as the inverse fourth power. It checked out perfectly; that is, as more DFTs were averaged, the spectral estimation approached the theoretical spectrum.

D. Dielectric Slab Propagation Model

The theoretical analysis of a uniform, lossy dielectric slab as a model for propagation in foliage was previously reported. The expression for the interface loss term associated with the dielectric slab model has recently been found to be incorrect. The corrected expressions for propagation into a dielectric slab are presented below. The major change is that the dielectric slab model now predicts an R^{-8} range dependence for the received signal power rather than the R^{-6} dependence previously stated.

For the case of the radar antenna above the foliage with the target in the foliage, the radar propagation factor may be expressed as the product of three factors

$$F^2 = F_1^2 \cdot F_2^2 \cdot F_3^2 \quad (1)$$

where

$$F_1^2 = \frac{1}{R^8}$$

$$F_2^2 = \frac{4}{\pi^2} (h_a - h_f)^4$$

and F_3^2 is a function of the target height and the forest parameters but is independent of range and antenna height.

This result indicates that the geometric range dependence of the radar equation is eighth power in contrast to the fourth power of normal free space propagation. It also notes that the received signal power will increase as the fourth power of the antenna height above the foliage.

Equation (1) is valid only for point targets. The idea of a point target moving along at a constant height is a convenient one, but it rarely describes a real situation. In most cases of interest, it seems that the effective target height will be varying up and down. If the correlation time of the target's vertical motion is short compared with the radar integration time, the situation is described by

$$F^2 = F_1^2 \cdot F_2^2 \cdot \left\{ \frac{1}{h_t} \int_0^{h_t} F_3^2 dh \right\} \quad (2)$$

$$= F_1^2 \cdot F_2^2 \cdot \overline{F_3^2}$$

This last factor has been evaluated for some typical foliage parameters at UHF. The results are plotted, as a function of target height, along with the corresponding factors for point targets and for point targets where ground reflections are absent in Figs. 1, 2 and 3. Although these curves are plotted for a specific forest height, they may be scaled for other forest heights since the factor F_3^2 is proportional to $\exp[-h_f]$.

E. Experimental Results

1. Propagation Tests

As an indication of the accuracy of radar range prediction with the dielectric slab model, Fig. 4 presents experimental data obtained last winter on the East Range of uniform pines. The solid curve was determined from the radar parameters and the propagation factor of Sec. I-D. The uniform slab model gives a quite accurate prediction of the mean received signal power, but it would not be expected that this simple model would account for variations from the mean since it assumes a wholly uniform dielectric and does not take into account the individual scatterers.

Figure 5 is a plot of received clutter power versus range on the same East Range. Again the slab model predicts quite accurately an average R^{-7} range dependence for received clutter power but variations from the average are quite large.

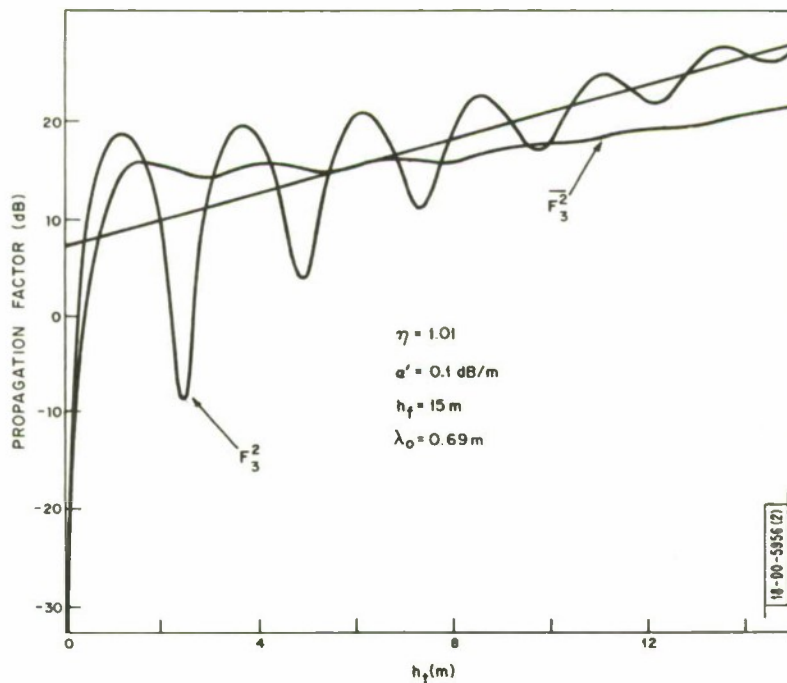

Fig. 1. Calculated propagation factors through woods.

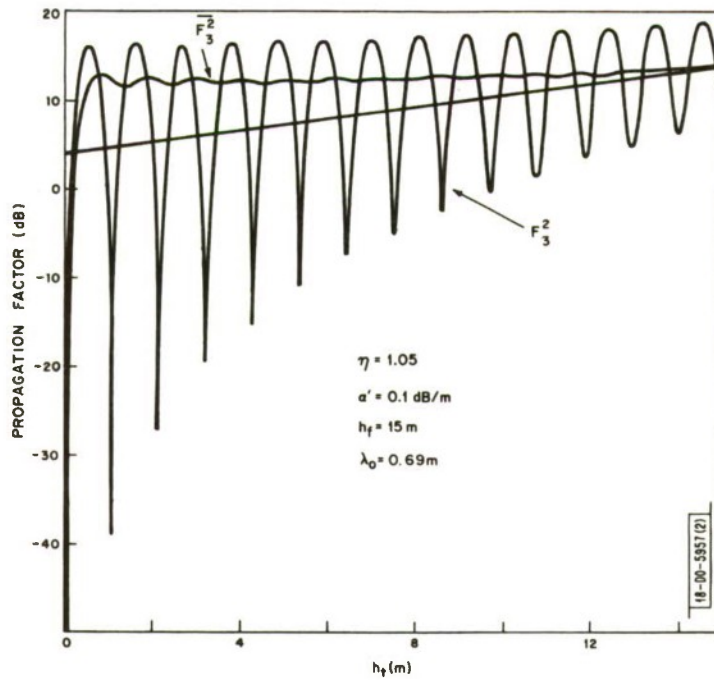

Fig. 2. Calculated propagation factors through forest.

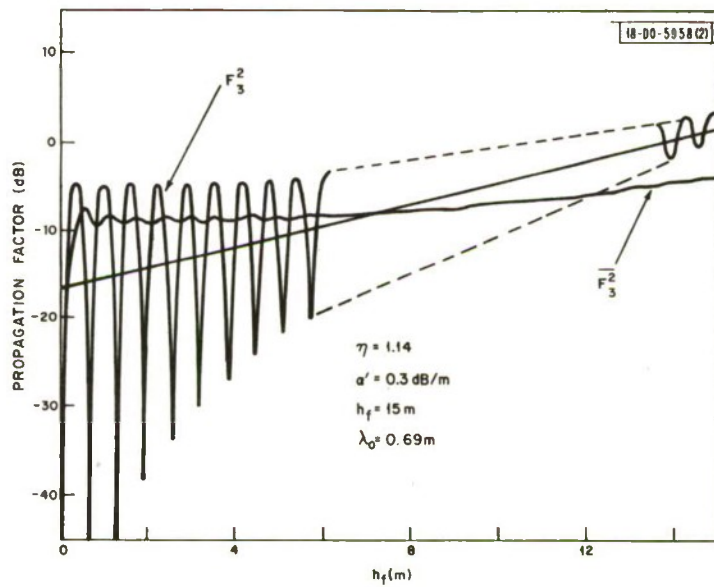

Fig. 3. Calculated propagation factors through jungle.

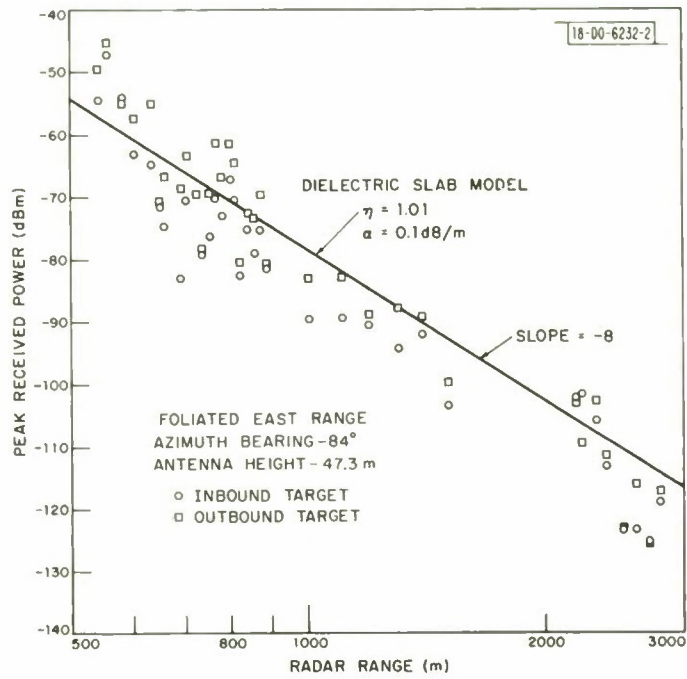

Fig. 4. Received signal power versus range.

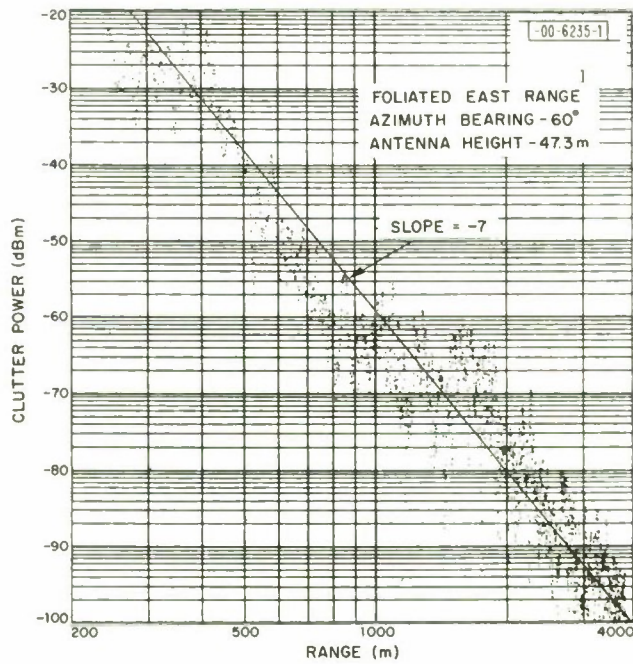

Fig. 5. Received clutter power versus range.

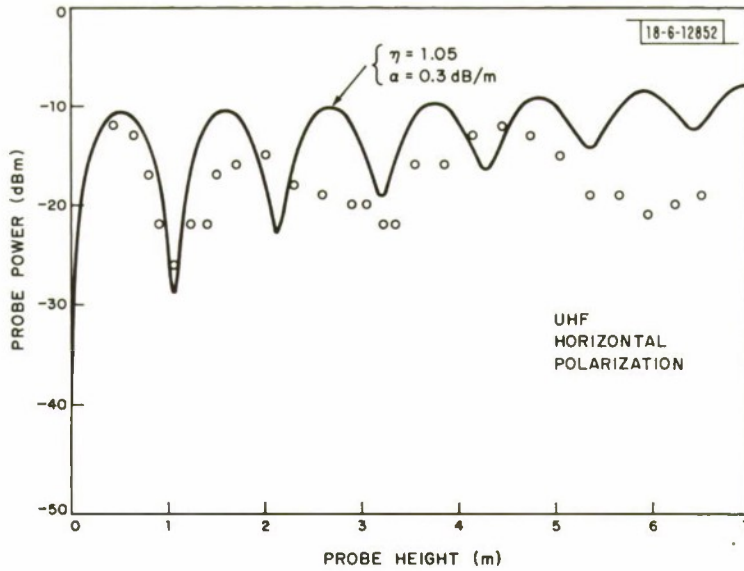

Fig. 6. Probe power versus height.

A number of vertical field profiles have been obtained at the new test site. These data were obtained with both horizontal and vertical probe antennas and photographs of the received pulse were taken at each point. These experiments are still continuing and much analysis of the results remains to be completed.

Figure 6 compares a measured vertical profile at UHF with a predicted profile from the dielectric slab model. A general agreement is noted, especially for low probe heights, but the actual lobing pattern is more complicated than that of the uniform slab model. That this is due to scattering effects is suggested by multipath signals observed on the probe receiver oscilloscope.

2. System Tests

A test was performed to determine whether or not the short term stability of the UHF transmitter would contaminate the clutter spectral data. A sample of the transmitter pulse was applied to the receiver through a 20- μ sec delay line and one of the receiver range gates was set for the range of this delayed pulse. A spectral analysis of the range gate output signal indicated that all frequency components in the frequency range from -50 to +50 Hz were more than 60 dB below the DC component.

A second possible source of error in spectral measurements could be motion of the transmitting antenna. It is possible to check for any deleterious effects of antenna motion by pointing the antenna toward a distant corner reflector and observing the spectrum of the reflected signal under various wind conditions. These tests indicated that the transmitting antennas are sufficiently stable for spectral measurements with wind velocities up to 15 mph. To assure good spectral measurements at higher wind velocities, a mechanical brake will be attached to the antenna rotator shaft.

Early tests with the MGP-10 on-site spectral analysis program indicated that:

- (a) There was insufficient AC gain between the boxcar circuits and the A/D converter for good spectral estimates with low wind conditions,
- (b) The residual hum and noise level at the input of the A/D converters were somewhat higher than expected because of pickup in the lines interconnecting the radar and computer vans.

New data amplifiers and new line drivers with twisted balanced lines were installed to overcome these deficiencies.

II. DEMONSTRATION RADAR

A. Introduction

A demonstration radar is being developed at the Laboratory. Its design philosophy and some design details have been discussed in previous quarterly technical summaries. This design has been studied in more detail in the past quarter and some of the parameters have been refined. Construction of the radar is proceeding. The important radar parameters as presently conceived are listed below.

| | |
|-----------------------|--|
| Frequency | 430 MHz |
| Antenna | |
| Type | Cylindrical, electronically steered array (for the demonstration radar only half of a cylinder will be built). |
| Size | 80 ft diameter by 8 ft 3 in. high |
| Azimuth beamwidth | 2.15° (one way) |
| Elevation beamwidth | 14°, approximately (one way) |
| Gain | 29 dB (approximately) |
| Pulsewidth | |
| Compressed | 0.1 μsec |
| Expanded | 3.2 μsec |
| Pulse repetition rate | 3599+ PPS |
| Average power | 300 watts |
| System noise figure | 8 $\frac{1}{4}$ dB (arising from a 2-dB preamplifier noise figure and about 6 dB of RF losses) |
| Coverage | The radar looks at 2048 range-azimuth cells at any one time. These can be distributed pretty much at random over 45° in azimuth and 16 nmi in range. |
| Data rate | The radar integrates coherently for 2.13+ seconds. At the end of each integration it can be moved to a new set of 2048 range-azimuth cells. |

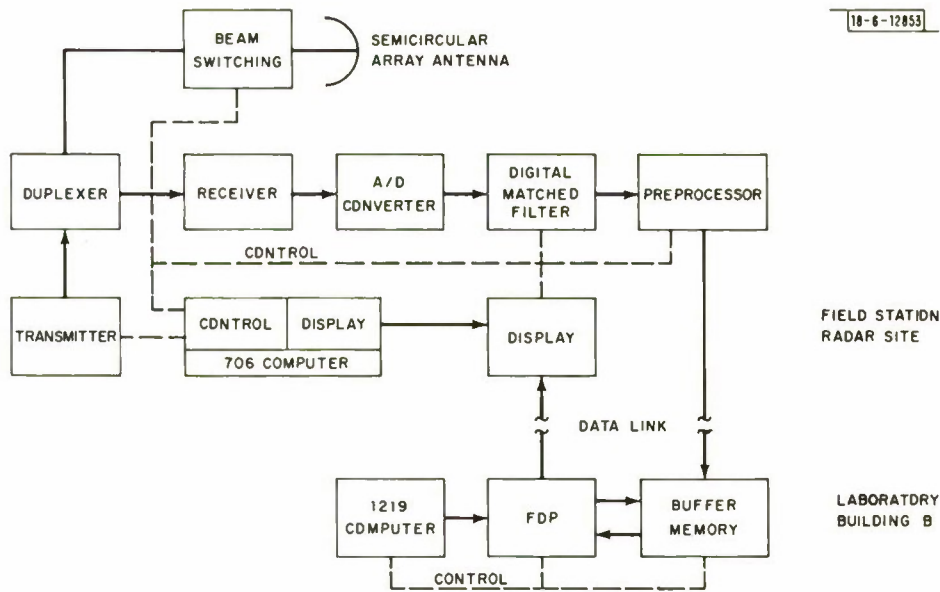

Fig. 7. Demonstration radar.

As noted above, the design and design philosophy of this radar system have been reported previously; however, a block diagram is included here (Fig. 7) for readers who may not have the previous reports.

The following paragraphs will discuss the design and current status of the antenna and some of the hard-wired digital signal processing subsystems in the demonstration radar.

B. Antenna

The basic concepts of this antenna system including the beam switching were described in general terms in the last quarterly technical summary. The main parameters of the circular array have now been determined and construction and procurement are under way as described below.

The frequency band over which the antenna must operate is 410 to 450 MHz. The antenna is required to produce a horizontally polarized beam having a total 3-dB width in azimuth of 2.15°. It is to be somewhat broader in elevation beamwidth consistent with a gain of 29 dB above isotropic as measured at the elements (that is neglecting all insertion losses due to switching and distribution networks).

Using the results obtained under similar circumstances with the CSR II antenna, the full 3-dB beamwidth in degrees depends upon the number of wavelengths in the diameter as: $BW = 69 (\lambda/D)$. This assumes that a 120° arc of the circle is excited and that an amplitude distribution of cosine squared on a pedestal of 0.1 is used. It would indicate that D/λ should be about 32.1. This would require a diameter of 73.5 feet based on a center frequency of 430 MHz.

The actual diameter being proposed is 80 feet ($\approx 35\lambda$) and the excited arc is 105° instead of 120°, but pattern computations indicate that this arrangement will give a beamwidth of about 2.15°.

The same computer program indicates that to obtain an antenna gain of about 29 dB relative to isotropic, the height of the cylindrical ground plane must be about 3.6λ (8.25 feet), and eight rows of dipoles arranged in a triangular lattice are required on the cylindrical reflector. The

triangular arrangement allows the number of elements to be reduced by 50 percent, so that there are only 4 elements instead of 8 in every column. (The elements in successive columns are staggered with respect to one another.) The successive columns of elements are separated from one another by 0.5λ and the elements in every column are separated by 0.8λ . The separation between any element and its closest neighbor is $\sqrt{0.5^2 + 0.4^2}\lambda = 0.64\lambda$. This close spacing is required to ensure that the effective element pattern (as influenced by the mutual effects of the array environment) does not have angles in which it delivers little if any radiation. The angle between successive columns of dipoles at the array center is

$$\approx \frac{0.5\lambda}{17.5\lambda} = \frac{1}{35} \text{ radian or } 1.635^\circ$$

This is also the angle between beam crossover points due to the way the beam switching operates. Since it was decided to drive 64 successive columns to form any one beam, the excited arc is 105° . The demonstration radar requires azimuth coverage of only 45° and since the angle beam crossovers is 1.635° , only 28 beams must be generated.

It is clear from this that a semicircular array of 110 columns (440 elements) is adequate to meet the system requirements. There are 9 columns of elements on each end of the array which are not directly excited even for the outermost beams. These columns of elements are important, however, since they will be excited by the driven elements and the discontinuity in the array will definitely cause some beam asymmetry in the outermost beams. This is not considered to be a serious matter, however, and if necessary, extra columns of elements could be added to the wings of the semicircle.

The design work required to build the array is very largely complete and construction is due to begin in the near future. The design of the reflector assembly is complete. It will consist of 22 identical panels each of which has 5 columns or 20 elements. Bids are now being solicited for construction of the dipoles and an order has been placed for the perforated metal sheet.

Following the same course of action that was used in the CSR II radar, the amplitude distribution is worked out to provide a symmetrical cosine squared on a pedestal type of cophasal distribution. This distribution takes the element pattern into consideration inasmuch as it considers the element to be a horizontally polarized dipole 0.177λ above the reflector surface. Mutual effects are not considered. Based on these considerations a distribution network has been defined and is now the subject of a request for bids. Based on past experience, it is felt that this will produce patterns having about 20-dB sidelobe levels. It is highly probable that shortcomings in the network (especially in the form of phase errors resulting from mutual effects) can be compensated by adjustments in line lengths between the distribution network and the switch.

Provisions have been made to measure the antenna aperture distributions with a small coupling loop inserted to sample the aperture field in amplitude and phase. By means of a suitable bridge comparison network, it will be possible to measure the aperture distribution and compute the radiation pattern. This is probably the only practical way that will be available to measure the antenna radiation pattern.

C. Antenna Switching

The switching system for the demonstration radar has been worked out schematically and is now in the process of being converted into actual hardware drawings. There are two identical circuits

and it is planned to divide each circuit into 12 parts which will be laid out in 12 separate stripline boards. These boards will be supported in the same sort of mounting frame and interconnected by coaxial cables. The transfer switches in the circuit will be constructed on individual disks which can be fastened to the stripline boards.

D. Preprocessor

1. Introduction

The preprocessor has the function of taking the digitized decorrelated radar video samples, performing pulse-to-pulse integration, gate selection and buffering to present data to the signal processor for the Doppler filtering operations. A block diagram is shown in Fig. 8.

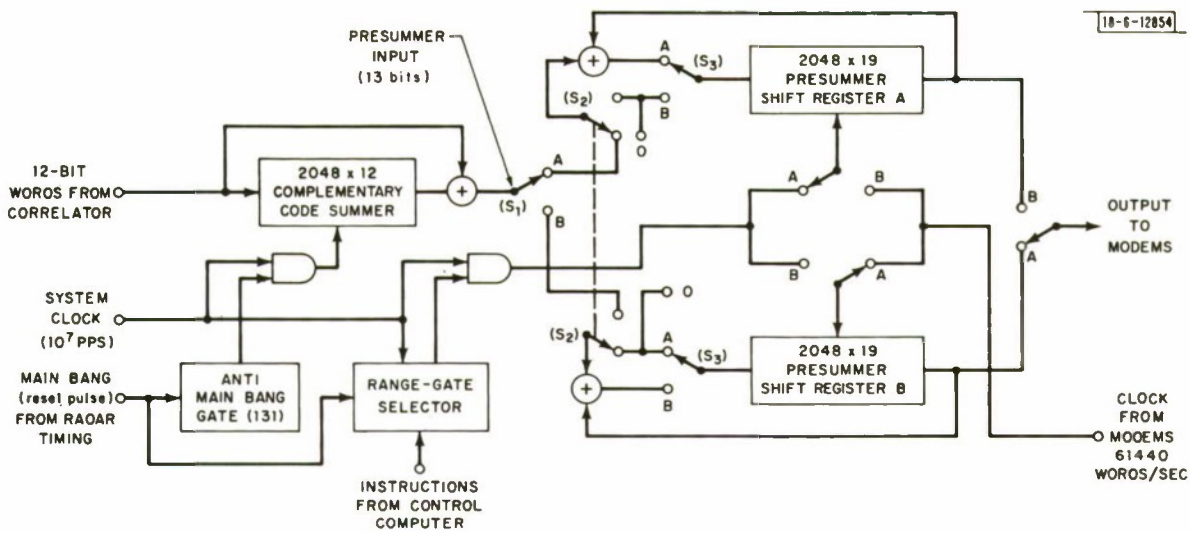

Fig. 8. Preprocessor channel.

Note: A single channel is shown. The radar uses two of these: one for the I channel and one for the Q channel.

The intrapulse coding is done by phase reversal modulation in accordance with a pair of complementary sequences. Alternate members of the complementary pair are transmitted on successive radar pulses. A pair of successive pulses are transmitted and received at each azimuth in order to realize very low sidelobe levels.

2. Timing Relationships

Figure 9 shows the basic timing relationships of the system. Both the digital pulse compression network and the complementary code summer operate essentially continuously. Thus, there is a total of 2778 10-MHz clock pulses in one radar period and the code summer ON gate passes 2048 of these in each period.

The output from the complementary code summer will be bursts of 2048 digital words appearing at the rate of one burst each 277.8 μ sec and within the burst, at the rate of 10 words/ μ sec.

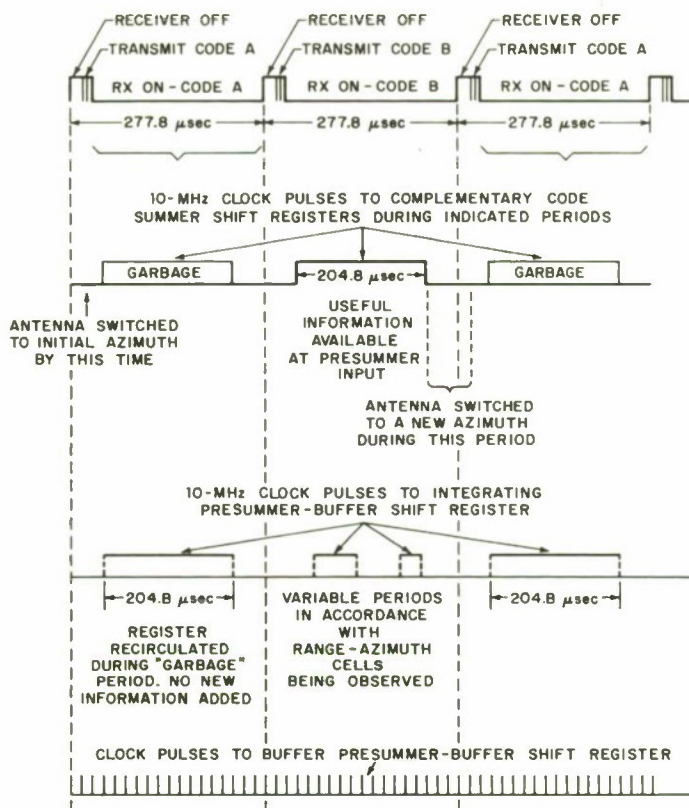

Fig. 9. Preprocessor timing.

Alternate bursts contain useful information (Fig. 8). Hence a basic unit of timing is the repetition period of bursts of useful information out of the complementary code summer ($555.6 \mu\text{sec}$). This basic unit is used rather than a single radar repetition period so that both members of the complementary code pair can be transmitted at each azimuth.

3. Preprocessor Functions

The two presummer buffer shift registers for each channel (see Fig. 9) serve as both integrators (presummers) and buffers. One acts as an integrator while the other is delivering previously integrated signals to the FDP. The period for this activity is exactly 60 of the basic units (i.e., $60 \times 0.5556 = 33.336 \text{ msec}$). One of the presummer delay lines integrates over that period while the other feeds 2048 words of integrated information to the FDP, at a rate of about one word every $16.28 \mu\text{sec}$. At the end of the 33.336-msec period, the roles of the two presummer shift registers are interchanged.

The capacity of the presummer buffer shift registers is 2048 words. Hence each 33.336-msec integration period can be devoted to handling data from 2048 range-azimuth cells. Each of these range-azimuth cells is presumed and sampled 64 times in order that the FDP perform

a 64-point discrete Fourier transform on each range-azimuth cell. This 64-point FFT takes up $64 \times 0.0333336 = 2.13335+$ seconds.

Thus the pattern of range-azimuth cells that is processed remains constant for 2.133+ seconds. The geometry of this pattern of range-azimuth cells (i.e., which 2048 range-azimuth cells are selected out of the 50,000 or so that are available) is quite arbitrary with the restriction that only one azimuth can be viewed over any one 555.6- μ sec interval.

The simplest arrangement involves equal weighting of the various azimuths used. In other words, the radar would dwell for 555.6 μ sec on the first azimuth selected, 555.6 μ sec on the next and so until all azimuths had been illuminated and then simply repeat that cycle until the entire 33.3336 msec had been used up. Such an arrangement would be straightforward to implement but may well not represent the most efficient utilization of the available radar transmitter power. The number of azimuths used must be no more than the 28 positions which will be available and it must be a factor of sixty.

A better strategy might be to devote half the range-azimuth cells to an "area search" function in which a single azimuth is illuminated every other 555.6 μ sec and the remaining time to "tracking" among some number of azimuths.

The simpler of these two schemes can be effected by simply letting the clock pulses to the integrating presummer shift register be the range selector. To implement the second scheme, it will be necessary to provide a range-gate selector which is independent of the clocking of the shift registers.

4. Preprocessor Implementation

The shift registers are being designed using currently available MOS dynamic shift register chips. MOS shift registers, which will operate at speeds as high as 10^7 pulses/sec, may not be available; thus some parallel operation of slower units may be necessary.

Range-gate selection is accomplished by selecting the clock pulses which are forwarded to the integrating presummer-buffer shift register. In addition, during those periods when the contents are being recirculated, the inputs to the presummer-buffer adder are set to zero so that the recirculated information is undisturbed.

At present, breadboard delay modules are being constructed using various MOS shift register chips. In the coming quarter an element type will be selected and the design completed.

III. AIRBORNE RADAR

A. Introduction

The study of multiple antenna airborne radar systems is well under way. Effort has been concentrated on finding a suitable framework for the common analysis of radars using both single and multiple antennas. Some effort was expended on further study of a general purpose digital processor for airborne radar. This work has now been set aside until a further analysis of multiple antenna radars, as related below, delineates better the algorithms required in such a processor.

Also described below is the possible effect of some of our ground-based radar measurements on the design of airborne radars.

B. Multiple-Antenna Airborne Radar Study

Besides using a long antenna on an aircraft to reduce the size of the clutter patch and the width of the main beam clutter spectral spread, several schemes have been proposed, and some tried experimentally, which seem to offer a better chance to detect moving targets in a fixed background of clutter. These schemes all have the common feature of employing more than one antenna.

In the Displaced Phase Center Antenna (DPCA) scheme, two antennas are mounted on the side of an aircraft and two samples are taken at a time interval such that the phase centers of the antennas coincide in space. The two samples are subtracted to eliminate all fixed ground clutter. The return from a moving target will have changed phase during this time interval so its signals won't cancel. An extension of the DPCA scheme is to subtract the signals from the real antennas as in the DPCA approach and then process the resulting difference signal further so as to form a large synthetic aperture, thus presumably reducing the clutter patch size which is in competition with the target. An extension of this scheme to several antennas has been suggested by J. L. Allen.

Recently, a series of interesting lunar and planetary radar measurements have been made at Lincoln Laboratory with the Haystack radar in which interferometric techniques have been used to resolve ambiguities in range-Doppler maps of Venus and also have been used to permit height or topographic measurements of the lunar surface. The corresponding airborne radar would employ narrow range gates and a high-performance Doppler processor to limit the size of the individual clutter patches as well as the Doppler spread of the clutter return from these patches. MTI capability could then be achieved by using interferometer techniques. Since moving targets having the same Doppler frequency shift characteristics as the fixed clutter will appear at different angular directions than the fixed clutter, the interferometer array has only to locate signals coming from directions other than the fixed clutter.

With so many apparently related suggestions there is an obvious need for some common framework into which they can all be put for comparison. One thing all these techniques have in common is that they sample the return from a range gate that might contain a target. A finite number of samples are taken in various but known ways so that a single column signal matrix S can be written down when the target velocity and location are assumed. By knowing the method of taking samples and the nature of the clutter, a square covariance matrix C for the clutter returns can be obtained. Now for a completely deterministic signal, the signal-to-clutter ratio is maximized[†] when the signal is weighted by the matrix $C^{-1} S^*$ (the inverse of the clutter matrix times the conjugate of the signal matrix) and the maximum signal-to-clutter ratio is proportional to $S_T C^{-1} S^*$, where S_T is the transpose of S .

Notice that any method of collecting samples can be put into this framework. The samples can be from one or many antennas at one or many intervals of time. Our problem, then, is to examine the different systems to see which produces the best signal-to-clutter ratio.

Practically all the effects which will cause a deterioration in system performance can be introduced as modifications on the elements of the clutter covariance matrix. These include: intrinsic clutter spectral spread, irregular aircraft motion, inaccuracy of phase center alignment

[†] D. F. DeLong, Jr. and E. M. Hofstetter, "On the Design of Optimum Waveforms for Clutter Rejection," IEEE Trans. Inform. Theory IT-13, 454-463 (July 1967).

of the various antennas, antenna pattern differences, discretions in the clutter, sideways motion of the aircraft, etc. Hopefully, one or two of these effects will dominate so that the system parameters can be configured to minimize them. The performance of the resulting system will be a function of target velocity so the system which gives best performance over the ranges of target velocity of interest can be chosen for implementation.

After choosing the most likely system, we will examine the feasibility of implementing the corresponding radar system and signal processor.

C. Ground Clutter and Target Returns at Small Depression Angles

Very few ground clutter measurements have been made at small depression angles ($<10^\circ$). The usual approximation is that the clutter returns follow a constant α -law, where α is defined by $\sigma_o = \alpha \sin \delta$ and δ is the depression angle. This law is the same as the Lommel-Seeliger scattering law which describes the uniformly bright surface of the moon at optical frequencies and which appears to fit most lunar and planetary observations at small angles.

Measurements of clutter made at 435 MHz by the radar in Florida (Sec. I) show an R^{-7} variation with range. These clutter returns were from a fairly uniform forest growing on very flat land. When allowance is made for the increasing width of the clutter patch with range (R^{+1}) and the normal free space attenuation R^{-4} , we see that σ_o varies as δ^4 instead of δ as predicted by the constant α -model.

The δ^4 law for σ_o can best be explained in terms of the refracted wave model (Sec. I) which predicts the field in the vicinity of the scatterers. The refracted wave model predicts a power return varying as R^{-8} for a given size scatterer located at a given height in the woods. We conclude that the δ^4 law for σ_o is a consequence of the propagation mechanism and not the scattering mechanism from individual scatterers; rather, the actual scattering cross section of an individual scatterer is nearly independent of angle at least for small angles. Also, at small angles and the lower microwave frequencies where refracted and reflected waves are important, the discrete scatterers, if they have any appreciable height, will be very important. The apparent cross section of a reflector will vary as the fourth power of its height over unfoliated regions and very strongly with height in foliated regions.

The target returns also depend on this propagation mechanism. When an airborne radar is searching for a moving vehicle on the ground, the return from the vehicle is typically much lower than that usually predicted using the R^{-4} radar equation. Ground lobing may be important in flat unfoliated regions and refraction of the waves at the top of the forest greatly reduces the ground target return when hidden under the trees, even when foliage attenuation has been considered. By the same token, the return from low flying vehicles may be much lower than expected and the vertical lobe structure may cause a change of radar visibility for aircraft being tracked.

| DOCUMENT CONTROL DATA - R&D | | |
|---|--|--|
| <i>(Security classification of title, body of abstract and indexing annotation must be entered when the overall report is classified)</i> | | |
| 1. ORIGINATING ACTIVITY (Corporate author) Lincoln Laboratory, M. I. T. | | 2a. REPORT SECURITY CLASSIFICATION Unclassified |
| | | 2b. GROUP None |
| 3. REPORT TITLE Radar Techniques Program Quarterly Technical Summary | | |
| 4. DESCRIPTIVE NOTES (Type of report and inclusive dates) Quarterly Technical Summary, 1 May through July 1970 | | |
| 5. AUTHOR(S) (Last name, first name, initial) Lebow, Irwin L. | | |
| 6. REPORT DATE 15 August 1970 | 7a. TOTAL NO. OF PAGES 28 | 7b. NO. OF REFS 2 |
| 8a. CONTRACT OR GRANT NO. AF 19(628)-5167 | 9a. ORIGINATOR'S REPORT NUMBER(S) Radar Techniques Program 15 August 1970 | |
| b. PROJECT NO. 649L ARPA Order 1559 4163 (Task 07) | 9b. OTHER REPORT NO(S) (Any other numbers that may be assigned this report) ESD-TR-70-236 | |
| c. | | |
| d. | | |
| 10. AVAILABILITY/LIMITATION NOTICES This document is subject to special export controls and each transmittal to foreign governments or foreign nationals may be made only with prior approval of ESD-EST-2. <i>Statement A.</i> | | |
| 11. SUPPLEMENTARY NOTES None | 12. SPONSORING MILITARY ACTIVITY Air Force Systems Command, USAF Advanced Research Projects Agency, Department of Defense | |
| 13. ABSTRACT This quarterly technical summary of the Radar Techniques Program, formerly called Tactical Radar Program, covers the period 1 May through 1 July 1970. The goal of the program is the application of modern techniques to the design of advanced Doppler radars for both ground and aircraft application. Work on ground-based radar, including propagation studies, is concentrated in Group 68. The digital signal processing work is performed principally in Group 64. Both groups collaborate in airborne radar work. Work at the Florida site on both propagation and spectral measurements is concluding. Most of the UHF and L-band data have been gathered with some spectral clutter tests still to be made during the next month. Reduction of data from the tests will continue throughout the next quarter. The demonstration radar system which incorporates the Fast Digital Processor (FDP) is proceeding on schedule. The antenna and tower structure are being fabricated with erection planned for the Lexington Field Station. The FDP, with the exception of three arithmetic elements (AEs), has been assembled and system tests have started. The AEs are on schedule. Work continues on airborne systems in the areas of multiple aperture antennas and advanced signal processing. | | |
| 14. KEY WORDS ground-based radar foliage-penetration radar digital signal processing airborne MTI radar phased-array antenna systems Fast Digital Processor (FDP) intrusion-detection radar | | |

DEPARTMENT OF THE AIR FORCE
HEADQUARTERS ELECTRONIC SYSTEMS DIVISION (AFSC)
LAURENCE G. HANSCOM FIELD, BEDFORD, MASSACHUSETTS 01730



REPLY TO
ATTN OF: TML (Lincoln Lab)

18 December 1973

SUBJECT: Review of Technical Report(s) Marked with a Distribution Limitation

TO: Defense Documentation Center
DDC-TSR
Cameron Station
Alexandria, Virginia 22314

1. As directed by ODDR&E, we have re-examined the need for a distribution limitation statement on the following document(s):

- (1) ESD-TR-70-236; AD #875 181L
- (2) _____
- (3) _____
- (4) _____
- (5) _____

2. This letter documents the review and our determination that the distribution statement(s) B should be replaced with the statement A.

FOR THE COMMANDER

EUGENE C. RAABE, Lt Colonel, USAF
Chief, Lincoln Laboratory Project Office